



L29

1U Liquid Cooler

PRODUCT SPECIFICATIONS

Table of Contents

- 1. PRODUCT DESCRIPTION 2
- 2. THERMAL PERFORMANCE CURVE..... 4
- 3. ASSEMBLY DRAWING 5
- 4. FAN SPECIFICATION 8

Model Number: L29

- Server Liquid Cooling Solution Recommended for CPU Models as Following
 - AMD® EPYC Series Processor, Socket SP3
 - AMD® Ryzen Threadripper Processor, Socket TR4/sTRX4
- For 1U Server and up

Overall Specification

- Cold Plate Module with Copper base
- Space-saving lightweight Radiator
- 4cm Cooling Fans with 4-Pin PWM Function
- Stand-alone Water Pump with Powerful Flow Rate 1.7 Litter Per Minute
- EPDM Hoses Assembled
- Mounting Accessories are included
- Shin-Etsu 7762 Thermal Compound Pre-Printed on Base
- Support CPU Overclocking Power Mode up to 280 Watts Heat Dissipation at 35°C or lower ambient temperature

Fan Specification

Model Number	DF124028BU - PWM
Dimension	40 x 40 x 28 mm
Bearing	Double Ball
Rated Voltage	12V
Rated Speed	At Duty Cycle 0~20%: 2000 ± 10% RPM At Duty Cycle 50%: 10000 ± 10% RPM At Duty Cycle 100%: 18000 ±10% RPM
Input Power	At Duty Cycle 0~20%: 2.40 W At Duty Cycle 50%: 7.20 W At Duty Cycle 100%: 15.60 W
Maximum Airflow	At Duty Cycle 0~20%: 2.944 CFM At Duty Cycle 50%: 14.72 CFM At Duty Cycle 100%: 30.6 CFM
Rated Static Pressure	At Duty Cycle 0~20%: 0.61 mm-H2O At Duty Cycle 50%: 15.12 mm-H2O At Duty Cycle 100%: 49.0 mm-H2O
Acoustical Noise	At Duty Cycle 0~20%: 16.00 dBA At Duty Cycle 50%: 44.24 dBA At Duty Cycle 100%: 57.00 dBA

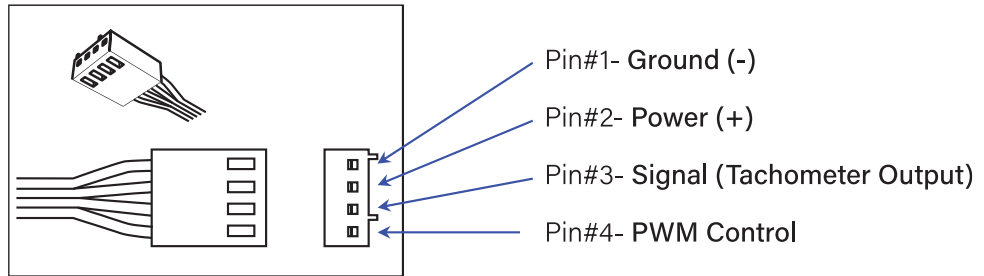
**Lead Wire Pin Out
Diagram**

L29 Thermal Performance Curve Cooling Performance vs. Airflow

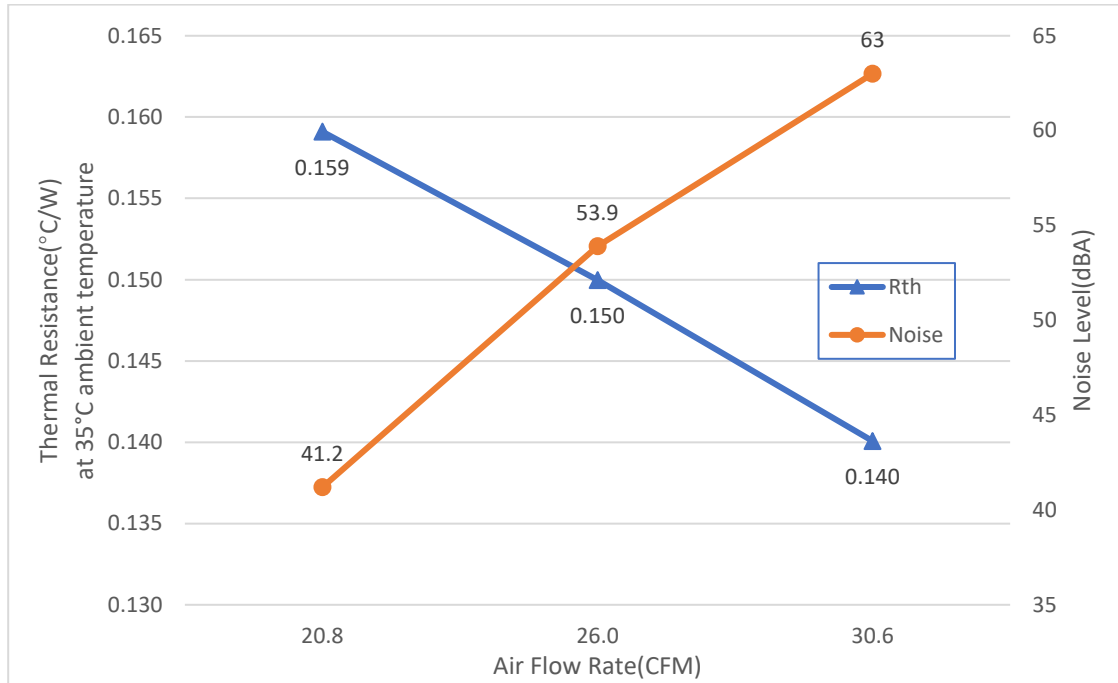

Cooling Performance vs. Fan Speed

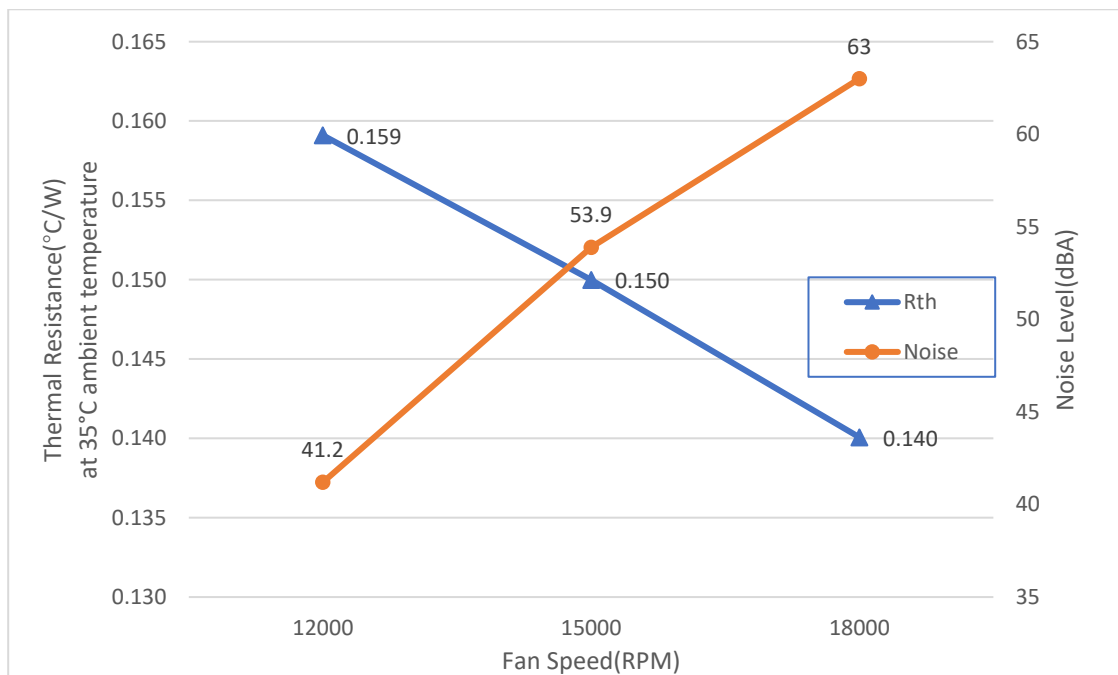

CONFIDENTIAL DOCUMENT

THIS DRAWING CONTAINS INFORMATION PROPRIETARY TO DYNATRON CORPORATION AND DYNAEON INDUSTRIAL CO., LTD. ANY REPRODUCTION, DISCLOSURE, OR USE OF THIS DRAWING IS EXPRESSLY PROHIBITED EXCEPT AS DYNATRON CORPORATION AND DYNAEON INDUSTRIAL CO., LTD. MAY OTHERWISE AGREE TO IN WRITING.

ASSEMBLY PARTS

REV#	DESCRIPTION	CHECKER	DATE
0.0	INITIAL RELEASE	LANG	11/21/2019
1.0	HOSE LENGTH CHANGE	LANG	12/13/2019
2.0	SPRING CHANGE WASHER CHANGE	JOY	10/14/20

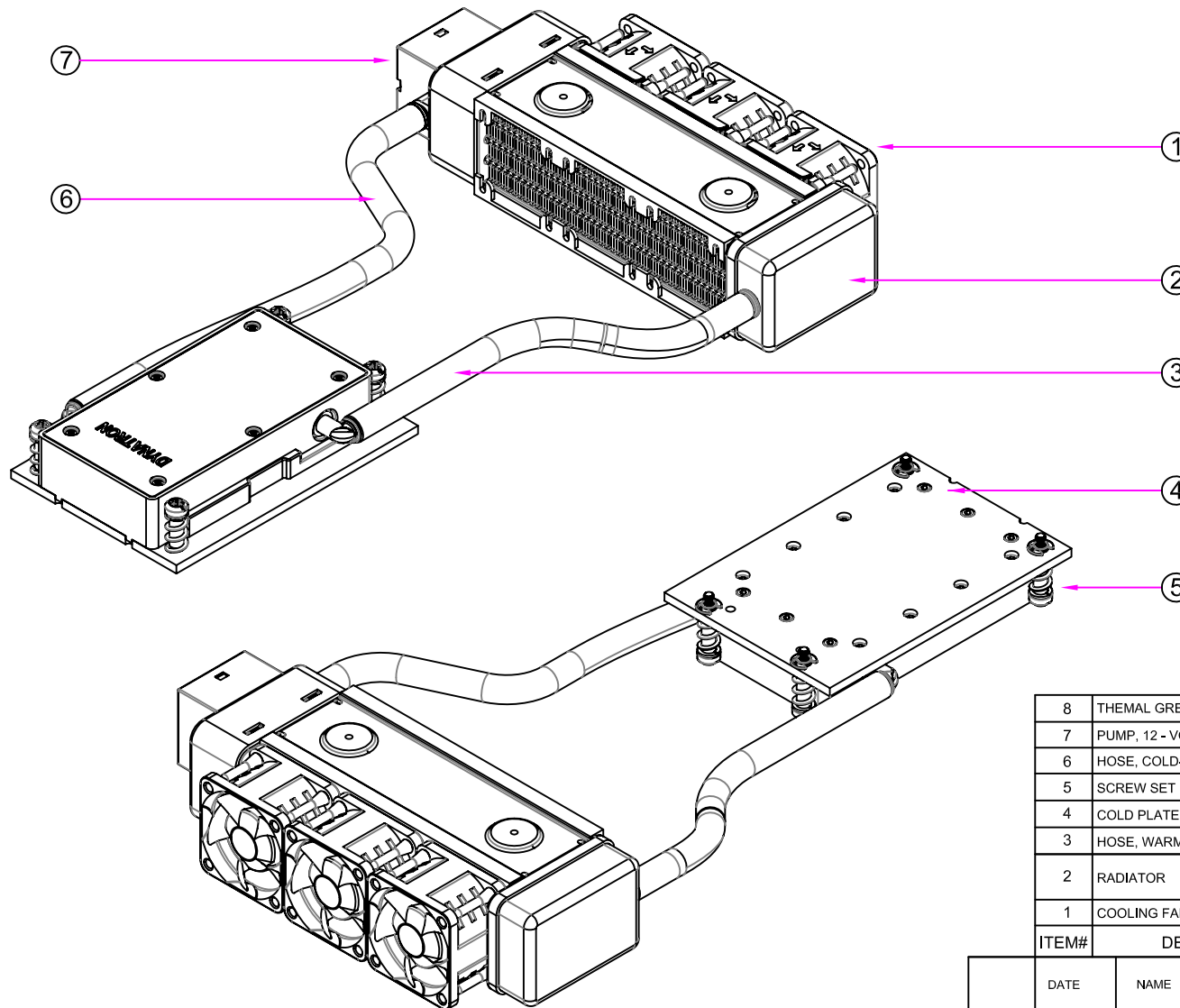

ITEM#	DESCRIPTION	MATERIAL	QTY.
8	THEMAL GREASE, PRE-PRINTED	SHIN-ETSU 7762	1
7	PUMP, 12 - VOLT	PLASTIC	1
6	HOSE, COLD-SIDE, 350 mm L	EPDM	1
5	SCREW SET	STEEL / SUS304	4
4	COLD PLATE	SEE PAGE 8	1
3	HOSE, WARM-SIDE, 300 mm L	EPDM	1
2	RADIATOR	ALUMINUM ALLOY SEE PAGE 7	1
1	COOLING FAN, DF124028BU -PWM, 18000RPM	PLASTIC	3

NOTES:

1. THE FIGURE IS FOR REFERENCE ONLY, AND NOT FOR SCALE

DATE	NAME	 DYNATRON CORPORATION	
DRAWN	12/13/2019		Engr
CHECKED	10/14/2020		JOY
ENG. APPR.			
MFG. APPR.			
Q.A.			
COMMENTS:			TITLE: Liquid Cooler Model L29 BOM & Assembly Drawing
		DWG. No:	DYN-EP-L29
		REV	1.0

1 2 3 4 5 6 7

REV#	DESCRIPTION	CHECKER	DATE
0.0	INITIAL RELEASE	LANG	11/22/2019

A

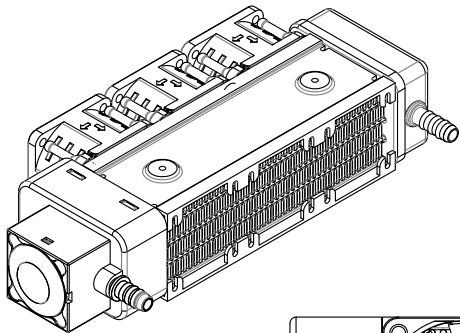

A

B

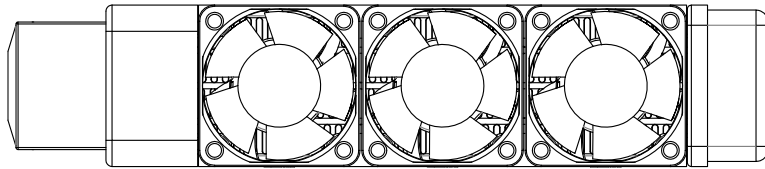

B

C

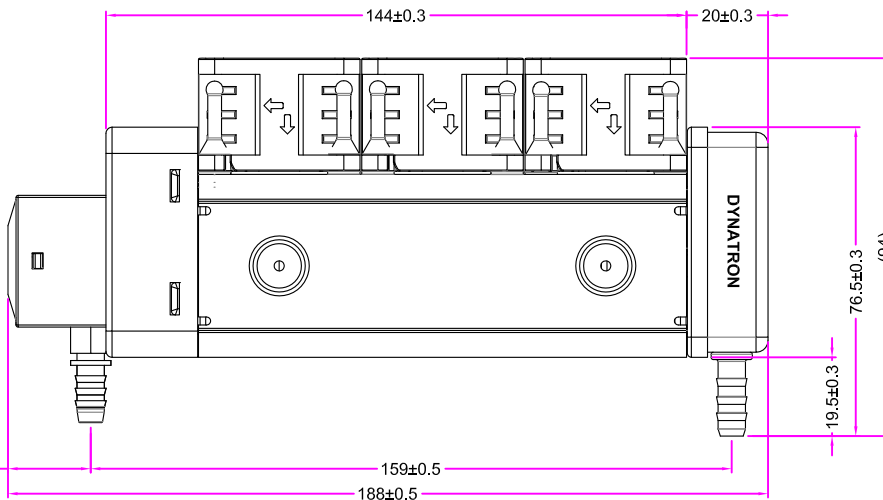
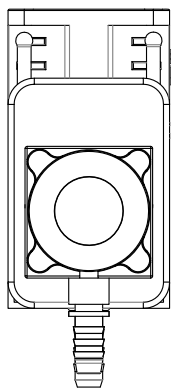

C

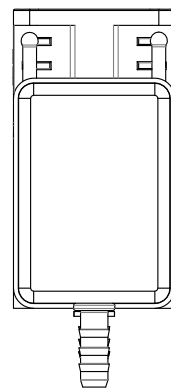

D

D

E

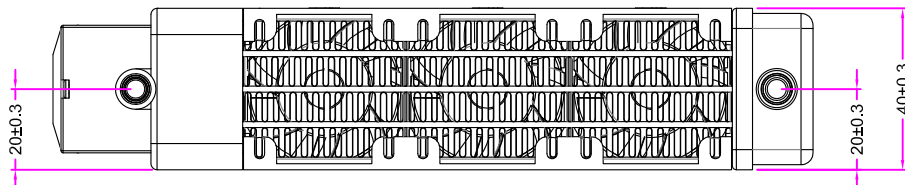

E

F

F

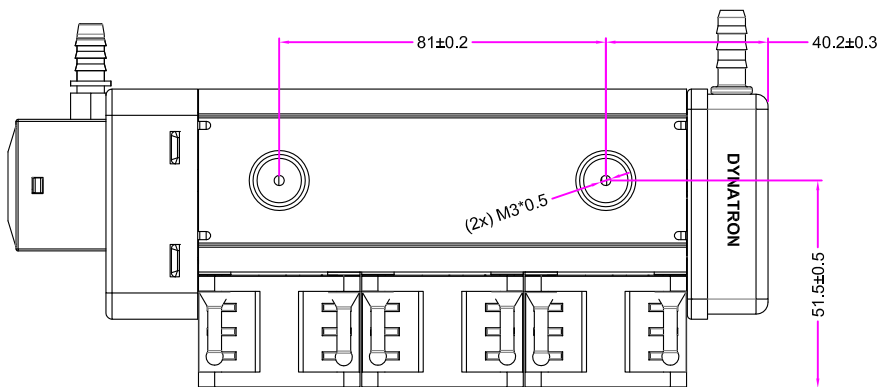

G

G

	NAME	DATE
DRAWN BY	ENGR	11/22/19
CHECKED BY	LANG	11/22/19
ENG. APPROVED		
MFG. APPROVED	-	-



DYNATRON CORPORATION

TOP MOTOR

TITLE: 1U Server Liquid Cooler Condenser
Overall Dimension Drawing

CONFIDENTIAL DOCUMENT

THIS DRAWING CONTAINS INFORMATION PROPRIETARY TO DYNATRON CORPORATION AND DYNAEON INDUSTRIAL CO., LTD. ANY REPRODUCTION, DISCLOSURE, OR USE OF THIS DRAWING IS EXPRESSLY PROHIBITED EXCEPT AS DYNATRON CORPORATION AND DYNAEON INDUSTRIAL CO., LTD. MAY OTHERWISE AGREE TO IN WRITING.

VIEW		DWG. No:	
UNITS	MM		

REV.
0.0

1 2 3 4 5 6 7

REV#	DESCRIPTION	CHECKER	DATE
0.0	INITIAL RELEASE	LANG	11/22/19
1.0	SPRING CHANGE WASHER CHANGE	JOY	10/14/20

A

A

B

B

C

C

D

D

E

E

F

F

G

G

H

H

1

2

3

4

5

6

7

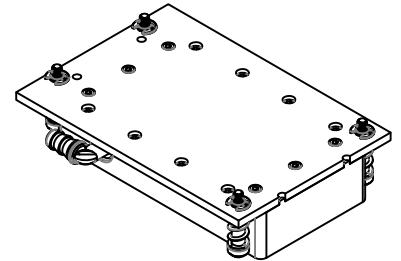
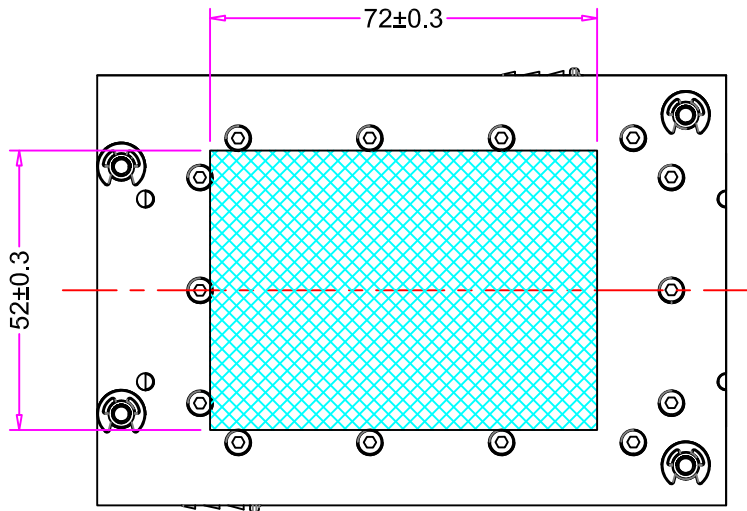
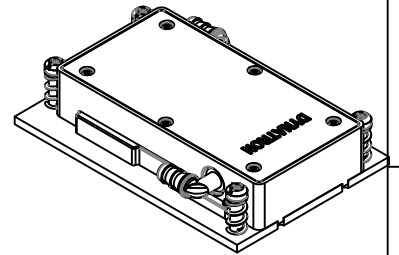
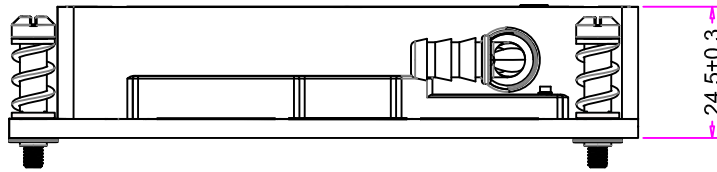
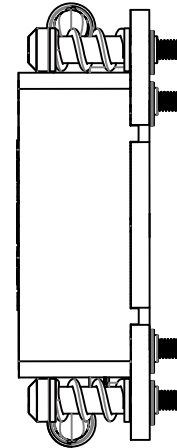
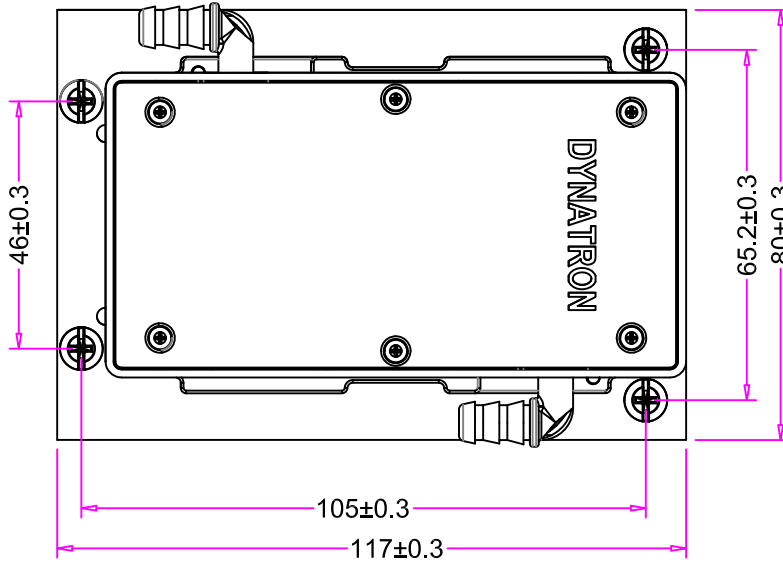
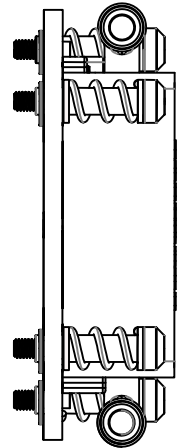
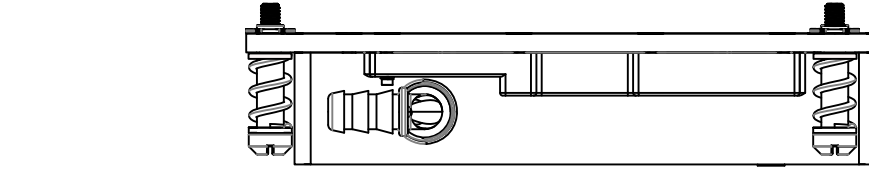

9	THERMAL GREASE, PRE-APPLIED	SHIN-ETSU 7762	1
8	C-CLIP	STEEL	4
7	WASHER	STEEL	8
6	SPRING	SUS304	4
5	SCREW, COLD PLATE MOUNTING	STEEL	4
4	SCREW, ENCLOSURE MOUNTING	STEEL	14
3	HOSE FITTING	PPS	2
2	COLD PLATE ENCLOSURE	PPS	1
1	COLD PLATE BASE	COPPER 1100	1
ITEM#	DESCRIPTION	MATERIAL	QTY.

	NAME	DATE
DRAWN BY	Engr.	11/22/19
CHECKED BY	JOY	10/14/2020
ENG. APPROVED		
MFG. APPROVED	-	-



TOP MOTOR

DYNATRON CORPORATION

TITLE: Cold Plate, Liquid Cooler
for AMD Socket SP3/TR3/TR4
BOM & Overall Dimension Drawing

CONFIDENTIAL DOCUMENT

THIS DRAWING CONTAINS INFORMATION PROPRIETARY TO DYNATRON CORPORATION AND DYNAEON INDUSTRIAL CO., LTD. ANY REPRODUCTION, DISCLOSURE, OR USE OF THIS DRAWING IS EXPRESSLY PROHIBITED EXCEPT AS DYNATRON CORPORATION AND DYNAEON INDUSTRIAL CO., LTD. MAY OTHERWISE AGREE TO IN WRITING.

VIEW

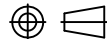

DWG. No:

REV.

UNITS

MM

DYN-BD-CP

0.0

1

2

3

4

5

6

7